



A Tata Steel Enterprise

HOLORIB® / SUPERHOLORIB®

Composite profiles made of steel sheathing, reinforcement and fire protection



SWISS MADE⁺



STEEL. COMPOSITE. HOLORIB®/ SUPERHOLORIB®.

COMPOSITE FLOOR DECK

HOLORIB® and SUPERHOLORIB® composite profiles of high-quality corrosion-protected steel have been extremely successful in the market for decades. The combination of concrete and steel gives composite building structures for floors that combine optimally the advantages of both these construction materials. In comparison with solid concrete slabs this enables significantly slimmer and therefore more economical superstructures to be implemented.

HOLORIB®/SUPERHOLORIB® composite floor deck is the most widespread composite floor deck, that optimally solves all problems regarding fire protection, dynamic loading and sound insulation. Furthermore, the dovetail shape enables fitting technical installations, light fittings and exposed ceiling systems. The use of HOLORIB®/SUPERHOLORIB® composite profiles saves the use of elaborate erection braces, ensures fast building processes and makes short schedules possible while fully retaining the usual benefits of reinforced concrete ceilings.

The composite action between the composite floor profile and the concrete is achieved in addition to the dovetail shape by various means approved by the construction authorities such as end anchorages by using crushed ends (BVA), by composite anchors or additional bolts in the top flange of SUPERHOLORIB®.

APPLICATION AREA

HOLORIB® and SUPERHOLORIB® composite floor profiles are not only used as a working platform, for structure stabilisation, as formwork or as an excellent installation support, they can also be used as reinforcement cross section area required for structural calculation. Further preferred application areas of these profiles are the construction of multistorey car parks and use in renovation and work in existing buildings.

This multiple use results in economical low-height ceilings between floors for all application areas of building construction. HOLORIB® and SUPERHOLORIB® composite profiles are convenient to use, simple to fit in the most varied supporting structures and thus universally applicable in the most varied applications!

CONTENTS

- 4 • **COMPOSITE PROFILES MADE OF STEEL**
- 4 • **SUPPORT DETAILS**
- 5–6 • **INFORMATION**
All you need to know about HOLORIB®/SUPERHOLORIB®
- 7 • **SERVICE**

HOLORIB®/SUPERHOLORIB®

COMPOSITE PROFILES MADE OF STEEL

Sheathing, reinforcement and fire protection – on request, also available without crimping in the bottom flange.

PROFILE

● HR 51/600

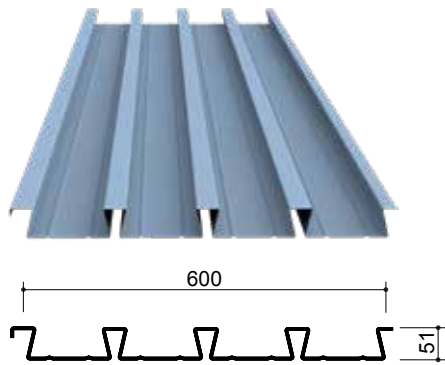

THICKNESS mm	0.75	0.88	1.00	1.25
STEEL kg/m ²	11.10	13.02	14.80	

● SHR 51/600

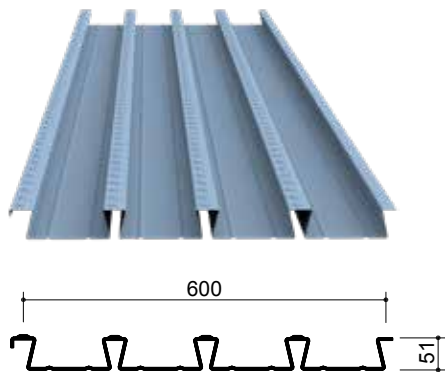

STEEL kg/m ²	11.10	13.02	14.80	18.50
-------------------------	-------	-------	-------	-------

SUPPORT DETAILS

Further technical information can be found in our leaflet HOLORIB®/SUPERHOLORIB® TECHNOLOGY

SUPPORTS

● CONTINUED CEILING

BVA

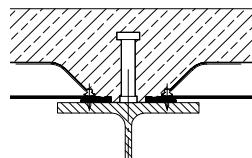

PE-FILLER

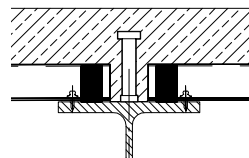

PERFORATION

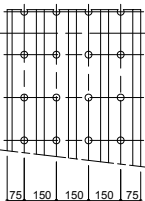
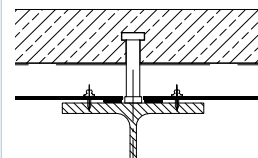

● CEILING END

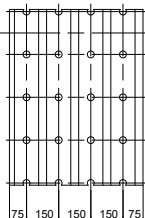
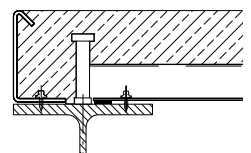
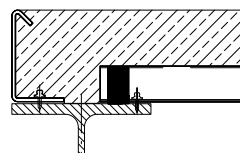
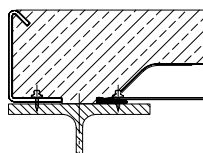

INFORMATION

WHAT YOU NEED TO KNOW ABOUT HOLORIB®/SUPERHOLORIB®

CONSTRUCTION

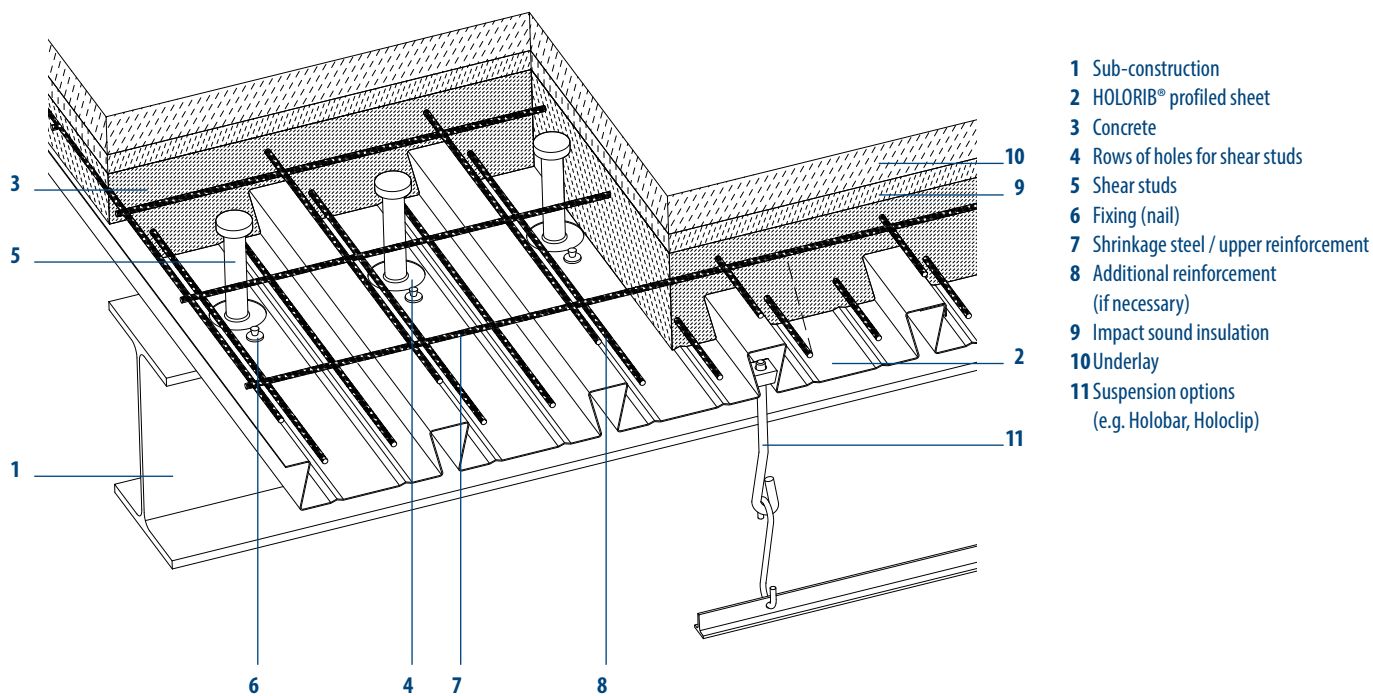

- 1 Sub-construction
- 2 HOLORIB® profiled sheet
- 3 Concrete
- 4 Rows of holes for shear studs
- 5 Shear studs
- 6 Fixing (nail)
- 7 Shrinkage steel / upper reinforcement
- 8 Additional reinforcement (if necessary)
- 9 Impact sound insulation
- 10 Underlay
- 11 Suspension options (e.g. Holoclip)

ADVANTAGES

The use of HOLORIB® and SUPERHOLORIB® profiles in construction has many advantages for different groups of specialists.

FOR ARCHITECTS AND PLANNERS ...

... it is decisive that they enable construction of slim economical ceilings in which reinforcement by allowing for the HOLORIB® profile section can be saved. This achieves a significant reduction in the ceiling weight compared to solid slabs. We can provide you with free calculation software for simple dimensioning and testable structural analyses. HOLORIB® and SUPERHOLORIB® profiles are generally approved by the building authorities for predominantly static and dynamic loading and ensure the demanded fire protection in most cases even without the need for further measures. The general building authority approvals/design approvals also cover the use of organically coated steel for both HOLORIB® and SUPERHOLORIB®.

Very varied surface finishes and decorative or coloured soffits are possible this way depending on corrosion protection requirements.

The dovetail shape of the profiles can be used as anchor rails for attaching supply lines, installations or light fittings by means of HOLOCLIP nuts and HOLOBAR bolts.

FOR CONTRACTORS AND CLIENTS ...

... other advantages become important: With the order-related industrial prefabrication and short assembly and construction times, building with HOLORIB® and SUPERHOLORIB® profiles enables fast completion of the building project. The profiles are delivered to the site in bundles and with the compact packaging method only need a minimal storage area, thereby causing little site traffic and needing only few crane operations to move them. These reasons have, above all, consequences as savings in the finances – since time is money!

HOLORIB® and SUPERHOLORIB® profiles are convenient to handle and simple to fit in the most varied supporting structures (steel, concrete, masonry, wood). The profiles are accessible for walking on and so they can be directly used as work platform and formwork. The storey-wise laying of the sheets directly after assembly of the supporting structure further contributes to the safety of the workers during the building work. In addition, a safe assessment of the fire performance by classifying the building elements into the desired fire-resistance classes REI 0–REI 180 is possible.



HOLORIB® AND SUPERHOLORIB® – THE DIFFERENCE

Both profiles are similar but do have some properties in which they differ from each other: HOLORIB® ensures the composite action via the surface bonding in combination with mechanical means of connection such as crushed ends, nails, screws, HILTI shear connectors or welded-through nails.

SUPERHOLORIB® profiles use the curls in the top flange to achieve composite action; in most application cases with a typical working load, no further mechanical means of connection are therefore required. The SUPERHOLORIB® profiles are approved with «floating support» – they end without a support in front of a stairway core, concrete wall etc.

CRUSHED ENDS / PERFORATION

Some extras are available for HOLORIB® and SUPERHOLORIB® composite profiles. For one, with crushed ends on one or both sides. This is understood as a crushing of the middle rib ends which gives an additional anchorage between the sheet and the concrete for longitudinal shear stresses. For another, the profile sheets can be perforated in the bottom flange for the recesses of the nails that are welded onto composite beams. Use our perforation plan 5.80 for this and send it with the order.

DIMENSIONING SOFTWARE

In addition to the HOLORIB® and SUPERHOLORIB® structural analysis leaflet 5.20, a free dimensioning program is available from Montana Building Systems Ltd. It was developed in collaboration with M. Mensiger GmbH and offers the user both an individual implementation of the composite floor deck and an easy means of providing the associated structural analysis. In this, the calculation of the state of the building is in accordance with the general building authority approvals/design approvals of the German Institute of Building Technology (DIBt) Z-26.1-4 (HOLORIB®) and Z-26.1-45 (SUPERHOLORIB®) which contain the current regulations of the applicable Eurocode. For the stress resultant calculation in the final state, the calculation methods according to plastic hinge theory with and without redistribution of moments and a calculation as a single-span girder chain make several options available for economical dimensioning of a HOLORIB®/SUPERHOLORIB® composite floor deck. The structural analysis for the composite floor deck can be done separately based on construction state and final state and taking into account prescribed and user-defined loading combinations and assembled in a testable printed report. In the matter of concrete quality, in addition to the usual type of normal concrete of strength class up to C50/60, lightweight concretes can also be selected from strength class LC 20/22 and bulk density class D1.6. This is above all to meet the need for light and flexible solutions in redevelopment and for changes of use or renovation. Ask us for this software that is free available!

SUSPENSIONS

The special dovetail shape of HOLORIB® and SUPERHOLORIB® composite profiles can be used as an anchor rail for inserting HOLOBAR bolts and HOLOCLIP nuts. Ceiling systems, pipe and electrical lines can be easily and quickly fixed in this way. HOLOBAR M8 and M10 are available for large loads (loadings with static axial load up to $P_{max}=2.25$ kN) and HOLOCLIP M6 and M8 for smaller loads (loadings with static axial load up to $P_{max}=1.5$ kN). By arranging these elements in groups, even loads up to 9 kN can be suspended. The components of the suspension system HOLOBAR/HOLOCLIP can be obtained from various companies in Switzerland and Germany. Ask us about where to obtain them.

SERVICE

SERVICE ELEMENTS FOR HOLORIB®/SUPERHOLORIB®

BASIC INFORMATION

- Approval/design approval Z-26.1-4 (HOLORIB®) and Z-26.1-45 (SUPERHOLORIB®)
- For interior use:
Standard finish with bottom flange beading galvanised to DIN EN 10346. Alternatively with additional 15 µm DU coating. Other versions on enquiry.
- For exterior use:
Standard version with bottom flange beading galvanised to DIN EN 10346 and a 25 µm polyester coating. Other versions on enquiry.
- BVA specifications:
Sheet length min. 2,000 mm. Single-side (left or right) or two-side crushing possible. Closing of the central 3 profile ribs (the overlap remains uncrushed for assembly).
- Perforation:
Sheet length min. 2,000 mm. Enter the perforations on the perforation plan 5.80 and send it in with the order (the precise specifications and possibilities can be seen on it).
- Tolerances:
in accordance with the implementation of the respective approval/design approvals
- Other applicable documents:
HOLORIB® Statics 5.20, HOLORIB® Technology 5.30, perforation plan 5.80



WEBSITE WWW.MONTANA-AG.CH

With additional product information and references.



CAD FILES

For downloading as dwg or dxf.
www.montana-ag.ch > Products > Composite profiles



DIMENSIONING TABLES

In the leaflet HOLORIB® Statics 5.20.
For downloading.



DIMENSIONING SOFTWARE

Request program.
www.montana-ag.ch > Services > Dimensioning software



TECHNICAL INFORMATION

In the leaflet HOLORIB® Technology 5.30.
For downloading.



COLOUR CARD

MONTACOLOR® Collection with full summary.
For downloading.



TENDER TEXTS

Prepared texts.
www.montana-ag.ch > Services > Tendering texts



www.montana-ag.ch

Trademarks of Tata Steel

Montana is a registered trademark of Tata Steel.

While care has been taken to ensure that the information contained in this publication is accurate, neither Tata Steel, nor its subsidiaries, accept responsibility or liability for errors or for information which is found to be misleading.

Before using products or services supplied or manufactured by Tata Steel and its subsidiaries, customers should satisfy themselves as to their suitability.

Copyright © 2018
Montana Bausysteme AG

MONTANA BAUSYSTEME AG

Durisolstrasse 11
CH-5612 Villmergen
Tel. + 41 56 619 85 85
Fax + 41 56 619 86 10
www.montana-ag.ch
info@montana-ag.ch

MONTANA SYSTÈMES DE CONSTRUCTION SA

CH-1028 Préverenges
Tél. + 41 21 801 92 92
Fax + 41 21 801 92 93
www.montana-ag.ch
info@montana-ag.ch

MONTANA BAUSYSTEME AG

Zweigniederlassung
D-86845 Grossaitingen
Tel. +49 8203 95 90 555
Fax +49 8203 95 90 556
www.montana-ag.ch
info@montana-ag.ch